

WN 054896
12/02

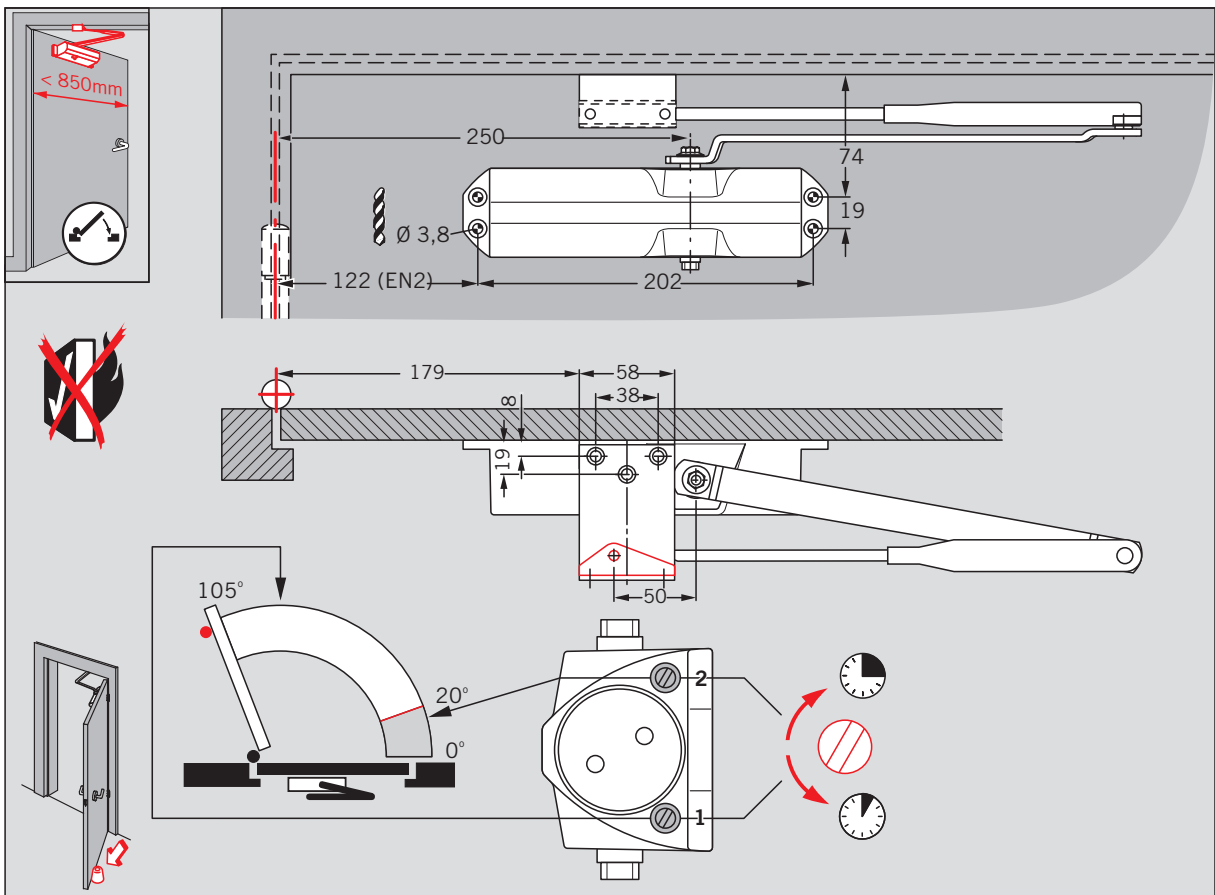
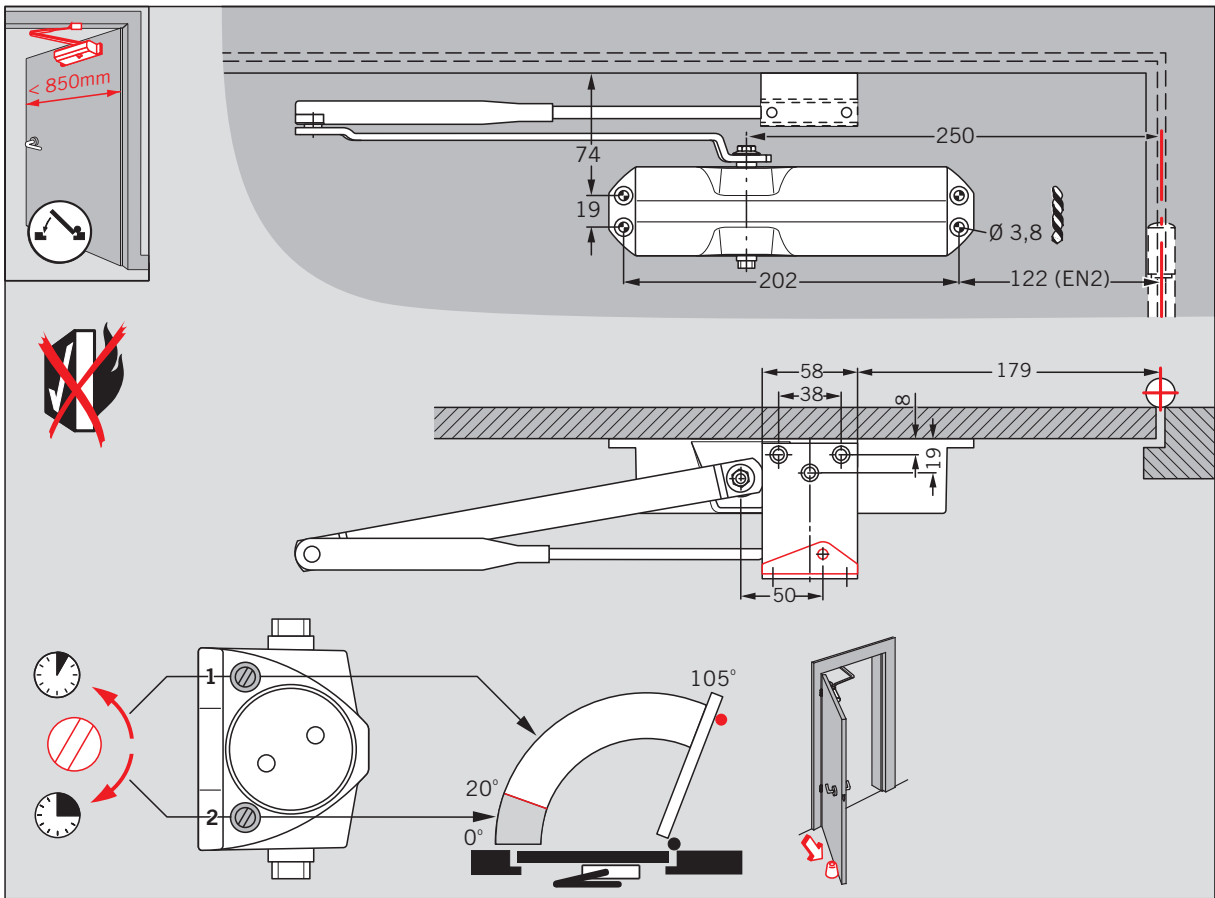

Änderungen vorbehalten